

Readers

Dear customers, your use of the broadcasting company speaker series. We would like to extend my heartfelt thanks to all of the Company manufactured products have been tested before, the commitment to keep its quality. Loud - speakers broadcast Pan-for hotels, commercial buildings, supermarkets, schools, leisure and entertainment venues, is your ideal choice. For your installation, commissioning and use of this product, the installation please read this note.

Safety Tips

- Please be sure to use the former reading detailed notes.
- Really pay attention to this manual and a safety with the important warning.
- Recommend that you keep this manual for future reference.

Common warning signs and security

The manual shown warning signs and security is to prevent the improper operation due to personal injury arising from the loss of property, please read before using this product must understand that this manual security symbols and Warning to indicate fully aware of potential risks.

 Warning Such as the inappropriate use of staff will cause injury, death and property damage.
--

When installed loudspeakers

- Definitely will not be allowed to speakers and any exposure in the rain-wet or water, may be inconsistent with ,or fire.
- Restricted by the provisions of the speakers on the voltage, such as the use of high voltage may cause electric shock or fire disaster. Is no pruning, distorted, or replacement of damaged wires.
- Avoid instability in the installation or set up speakers, such as shaking the table or flat surface , the speaker can avoid falling caused personal injury or property damage.
- Speakers will be installed in support of the speaker or the weight of a solid shelf. Speaker swap can be avoided caused personal injury or property damage.
- Wet hands must not be admitted into or plugs, may lead to electric shocks.
- The allocation of plugs, make sure that pull plugs, rather than pull wires. The use of a damaged power line of machinery may cause fire or electric shock.
- Mobile speaker, you plug the prior allocated. If the speaker and plugs may be moving together will cause fire or electric shock. For plugs, identified as plugs for grip.
- Will not be allowed to speakers on the vent cover. May cause internal heating caused by the fire.
- Avoid speakers installed in the humidity or dust, direct contact with the sun, from the near-electric, or smoke or steam, may cause fire or electric shock.

itC

Ceiling Speaker



T-104U

OWNER'S MANUAL

Dimension

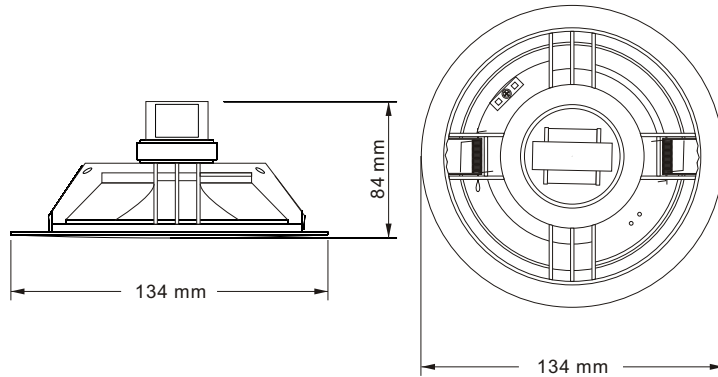

T-104U

Specifications

Model	T-104U
Power Taps@100V	1W/2W/3W
Power Taps@70V	0.5W/1W/1.5W
Impedance	Black:COM,Red:10K Ω ,Green:5K Ω ,White:3.3K Ω
SPL(1W/1M)	88dB
Freq Response	100-16KHz
Cutout Size	108 mm
Dimensions	134X84 mm
Weight	0.5Kg

Installation

Step 1

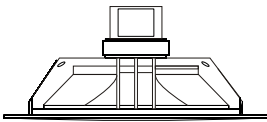

Step 1: First measuring tools, measuring speaker mounting hole bit. Mounting holes and then mask bit must be less than the speakers on both sides of iron fittings, push to the loudspeakers, so that speakers on both sides of metal plates into a 90-degree vertical.

Step 2

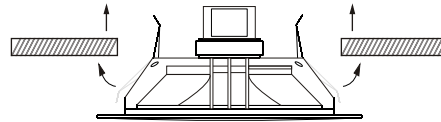

Step 2: The speaker to the ceiling mounting holes a good push.

Step 3

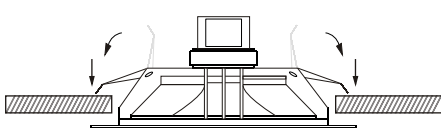

Step 3: When the speaker standup to the ceiling of the mask, the metal plates on both sides of the speaker to change less than 90-degree angle. Speakers on both sides of metal plates so that the ceiling caught.

Step 4

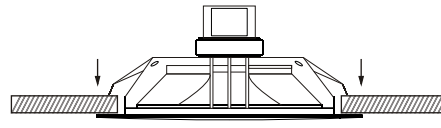

Step 4: This is the net effect of speaker installation.

Label Stickers

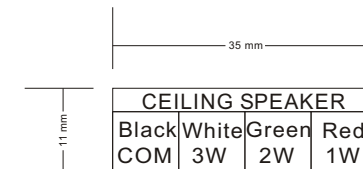

T-104U